

D-2 ver.2 T User Guide

D/A Converter

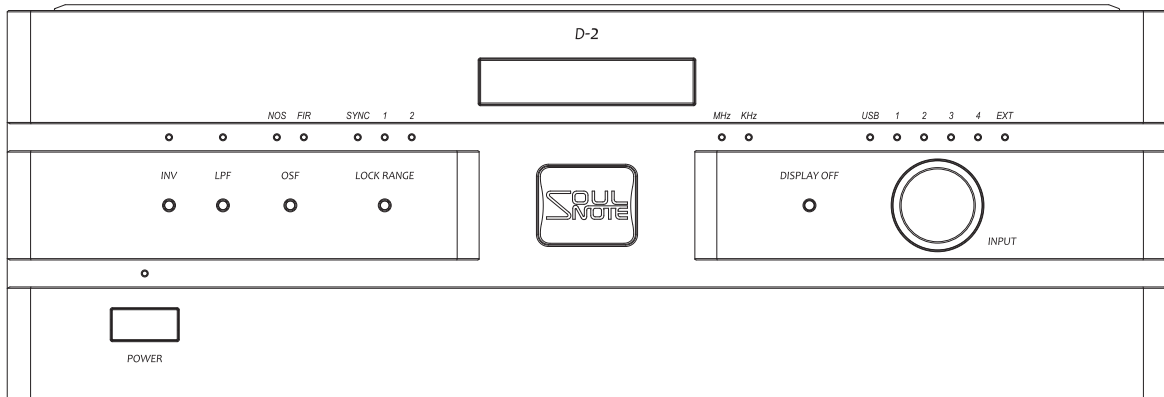

Table of Contents

Safety Precautions.....	3
Front Panel Names and Functions	6
Rear Panel Names and Functions.....	8
USB Connection with a Computer	10
Balanced Input/Output.....	10
Attaching the Spike Pins.....	10
Troubleshooting.....	11
Maintenance	11
Specifications.....	11

Supplied Accessories

• User Guide (this manual)	1	• Spike pin	3
• Power cable	1	• Hex key for spike pins	1

- The official name of Windows® is Microsoft® Windows® Operating System.
- Windows® 10, Windows® 8.1, Windows® 8, and Windows® 7 are either registered trademarks or trademarks of Microsoft Corporation in the United States.
- Apple, Mac, Mac OS, and OS X are either registered trademarks or trademarks of Apple Inc.
- Android is a trademark of Google LLC.
- All other names of systems, products, and services are trademarks of their respective owners.
- In the manual, the ™ or ® marks are not specified.

Safety Precautions



CAUTION

RISK OF ELECTRIC SHOCK
DO NOT OPEN



CAUTION: TO REDUCE THE RISK OF ELECTRIC SHOCK, DO NOT REMOVE COVER (OR BACK). NO USER-SERVICEABLE PARTS INSIDE. REFER SERVICING TO QUALIFIED SERVICE PERSONNEL.



The lightning flash with arrowhead symbol, within an equilateral triangle, is intended to alert the user to the presence of uninsulated “dangerous voltage” within the product’s enclosure that may be of sufficient magnitude to constitute a risk of electric shock to persons.



The exclamation point within an equilateral triangle is intended to alert the user to the presence of important operating and maintenance (servicing) instructions in the literature accompanying the product.

WARNING

TO REDUCE THE RISK OF FIRE OR ELECTRIC SHOCK, DO NOT EXPOSE THIS APPLIANCE TO RAIN OR MOISTURE.

A warning that an apparatus with CLASS I construction shall be connected to a MAINS socket outlet with a protective earthing connection.

IMPORTANT SAFETY INSTRUCTIONS

READ BEFORE OPERATING EQUIPMENT

This product was designed and manufactured to meet strict quality and safety standards. There are, however, some installation and operation precautions which you should be particularly aware of.

1. Read these instructions.
2. Keep these instructions.
3. Heed all warnings.
4. Follow all instructions.
5. Do not use this apparatus near water.
6. Clean only with dry cloth.
7. Do not block any ventilation openings.
Install in accordance with the manufacturer's instructions.
8. Do not install near any heat sources such as radiators, heat registers, stoves, or other apparatus (including amplifiers) that produce heat.
9. Protect the power cord from being walked on or pinched particularly at plugs, convenience receptacles, and the point where they exit from the apparatus.
10. Only use attachments/accessories specified by the manufacturer.
11. Use only with the cart, stand, tripod, bracket, or table specified by the manufacturer, or sold with the apparatus. When a cart is used, use caution when moving the cart/apparatus combination to avoid injury from tip-over.
12. Unplug this apparatus during lightning storms or when unused for long periods of time.
13. Refer all servicing to qualified service personnel. Servicing is required when the apparatus has been damaged in any way, such as power-supply cord or plug is damaged, liquid has been spilled or objects have fallen into the apparatus, the apparatus has been exposed to rain or moisture, does not operate normally, or has been dropped.
14. Batteries shall not be exposed to excessive heat such as sunshine, fire or the like.



CAUTION:

- To completely disconnect this product from the mains, disconnect the plug from the wall socket outlet. The mains plug is used to completely interrupt the power supply to the unit and must be within easy access by the user.
- Never use the unit with any other cord except the supplied power cord.

NOTE ON USE

WARNINGS

- Avoid high temperatures.
Allow for sufficient heat dispersion when installed in a rack.
- Handle the power cord carefully.
Hold the plug when unplugging the cord.
- Keep the unit free from moisture, water, and dust.
- Unplug the power cord when not using the unit for long periods of time.
- Do not obstruct the ventilation holes.
- Do not let foreign objects into the unit.
- Do not let insecticides, benzene, and thinner come in contact with the unit.
- Never disassemble or modify the unit in any way.
- Ventilation should not be impeded by covering the ventilation openings with items, such as newspapers, tablecloths or curtains.
- Naked flame sources such as lighted candles should not be placed on the unit.
- Observe and follow local regulations regarding battery disposal.
- Do not expose the unit to dripping or splashing fluids.
- Do not place objects filled with liquids, such as vases, on the unit.
- Do not handle the mains cord with wet hands.
- When the switch is in the OFF position, the equipment is not completely switched off from MAINS.
- The equipment shall be installed near the power supply so that the power supply is easily accessible.

DECLARATION OF CONFORMITY

We declare under our sole responsibility that this product, to which this declaration relates, is in conformity with the following standards:

EN60065, EN55032, EN55020.

Following the provisions of Low Voltage Directive 2014/35/EU and EMC Directive 2014/30/EU.

A NOTE ABOUT RECYCLING:

This product's packaging materials are recyclable and can be reused. Please dispose of any materials in accordance with the local recycling regulations. When discarding the unit, comply with local rules or regulations.

Batteries should never be thrown away or incinerated but disposed of in accordance with the local regulations concerning battery disposal. This product and the supplied accessories, excluding the batteries, constitute the applicable product according to the WEEE directive.



Pb

CAUTIONS ON INSTALLATION

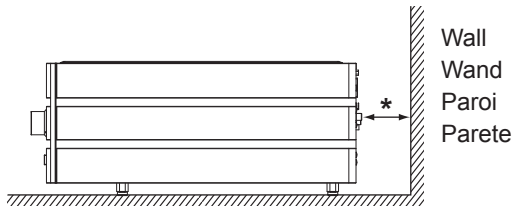
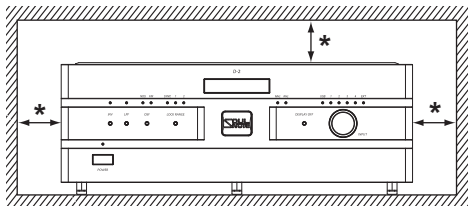

*** For proper heat dispersal, do not install this unit in a confined space, such as a bookcase or similar enclosure.**

- Leave sufficient clearance (at least 10 cm) from the wall, (at least 5 cm) from top surface of the unit.
- Do not place any other equipment on this unit.

Front Panel Names and Functions

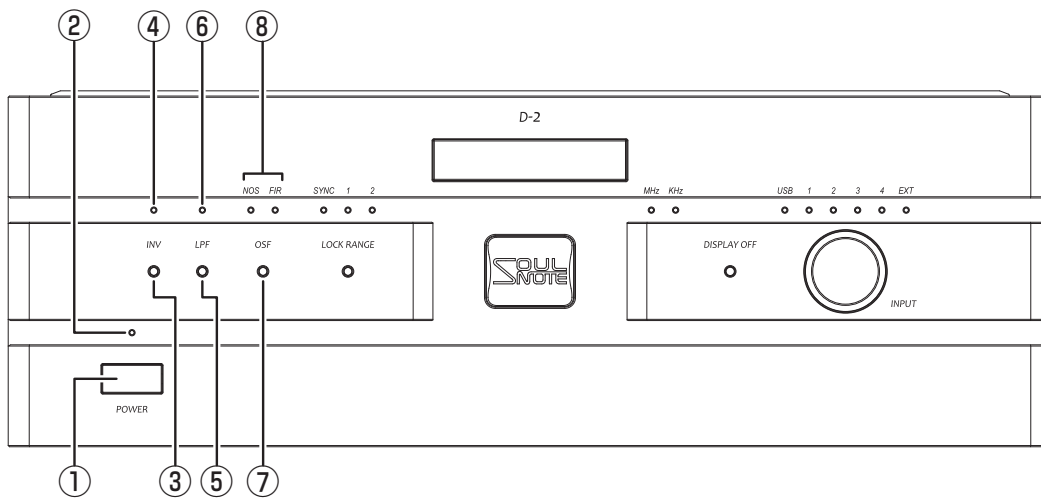

① Power Switch (Power)

Press to turn on the power, and press again to turn off. Sound is output after approx. 5 seconds have passed since the power switch is turned on.

② Power Indicator (Power)

When the power is on, the indicator is lit red. When in external clock mode, the indicator is lit blue.

③ Invert Switch (INV)

Press to set the analog output phase to the inverted phase. Press again to set it back to the original setting.

④ Invert Indicator

When in the inverted phase, the invert indicator is lit red.

⑤ Low-path Filter Switch (LPF)

Press to turn on the analog low-path filter that attenuates signals by 8 dB at 100 kHz. Press again to turn it off.

Note:

- Setting to OFF is recommended to achieve higher audio quality.

⑥ LPF Indicator

When the analog low-path filter is on, the indicator is lit red.

⑦ Over Sampling Switch (OSF)

With this switch, over-sampling mode can be switched between NOS (Non over Sampling) mode and FIR mode. When in NOS mode, the NOS indicator is lit green, and when in FIR mode, the FIR indicator is lit red.

Notes:

- Setting to NOS is recommended to achieve higher audio quality.
- The mode cannot be switched during audio playback via USB input (when the sampling frequency is displayed). To switch the mode, stop the audio playback and wait until the frequency display disappears.
- For FIR mode, the filter characteristic can be selected from "FIR1" and "FIR2" by using the FIR switch on the rear panel.
- If the over sampling switch is pressed when it is disabled, the indicator flashes.
- During DSD playback, NOS mode is disabled. The lock range state automatically sets to SYNC mode.

⑧ NOS mode Indicators

When in NOS mode, the NOS indicator is lit green, and when in FIR mode, the FIR indicator is lit red.

Note:

- The over sampling indicator does not change during audio playback via USB input.

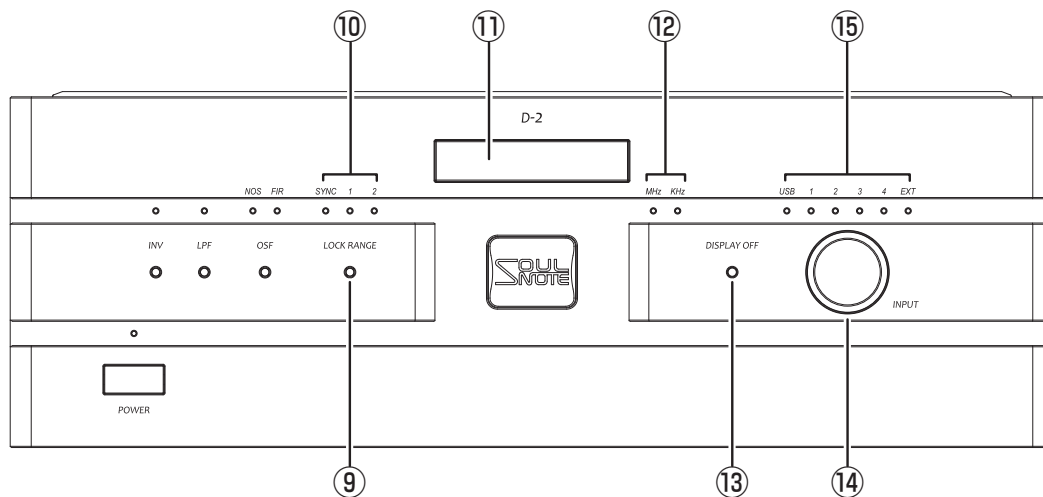

⑨ Lock Range Switch (LOCK RANGE)

During FIR mode, the lock range can be changed during COAX or AES/EBU input by using this switch.

Notes:

- During USB input, the lock range is fixed to SYNC (synchronization mode).
- During NOS mode, this switch cannot be operated.
- If the switch is pressed when it is disabled, the indicator flashes.

⑩ Lock Range Indicators

When in FIR mode, the lock range state is indicated.

SYNC: Synchronization mode (mode with the highest audio quality)

- [1]: Mode with the narrowest lock range
- [2]: Mode with the standard lock range

Note:

- When in NOS mode, the indicator is turned off.

⑪ Sampling Frequency Display

During USB input, sampling frequency of the input source is displayed.

Note:

- The sampling frequency is not displayed during COAX or AES/EBU input.

⑫ Sampling Frequency Unit Indicators

The unit (MHz/kHz) of the sampling frequency is indicated.

⑬ Display OFF switch (DISPLAY OFF)

Press to turn off all indicators and display except for the power indicator. Press again to turn on the display.

Note:

- When the display is off, operating a switch turns on the display for approx. 5 seconds and then the display turns off again.

⑭ Input Selector (INPUT)

The input source can be selected with this selector.

⑮ Input Selector Indicators

The input source selected is indicated.

Note:

- The EXT indicator is for a future extension.

Rear Panel Names and Functions

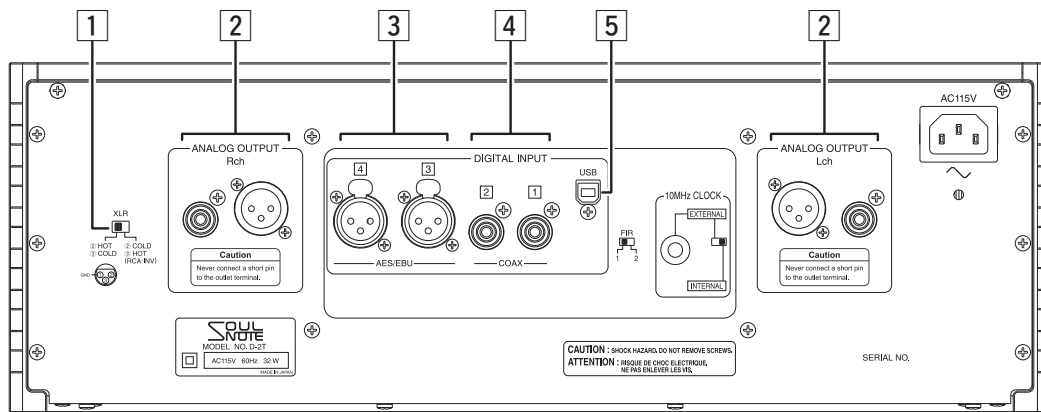

1 XLR Type Selection Switch (XLR)

The balanced output terminal type can be selected from the European type and USA type.

Euro type: pin 2 is HOT and pin 3 is COLD

USA style: pin 2 is COLD and pin 3 is HOT

Notes:

- The default setting of this equipment is the European type.
- When the USA type is selected, the RCA terminal output phase is reversed.

2 Analog Output Terminals

The line input terminal of an amplifier is connected to one of these terminals. One terminal is an unbalanced output terminal (RCA terminal) and the other is a balanced output terminal (XLR terminal).

Notes:

- From an audio quality standpoint, it is not recommended to use both the unbalanced output terminal and the balanced output terminal at the same time.
- DO NOT connect a short pin into the output terminals. It causes a malfunction.

3 AES/EBU Input Terminals (AES/EBU 3, 4)

External devices equipped with an AES/EBU digital output terminal can be connected to these terminals by using an XLR digital cable.

Note:

- These input terminals do not support dual AES/EBU.

4 Coaxial Input Terminals (COAX 1, 2)

External devices equipped with an S/PDIF format applicable digital output terminal can be connected to these terminals by using a 75-ohm coaxial digital cable.

5 USB 2.0 Input Terminal

A device such as a music server or a computer can be connected to this terminal by using a USB 2.0 cable with a type-B connector (standard type). USB connection is achieved through a duplex communication between this equipment and the device. Jamming or cutting the communication may result in serious errors in the operating system of the device. When the device is connected via USB, do not perform the following operations.

- Repeatedly turning on and off the power of this equipment
- Repeatedly switching the input between USB and any other settings by using the input selector
- Repeatedly plugging and unplugging the USB cable
- Connecting via a USB hub

Notes:

- For a Windows computer, a designated driver is required. The driver can be downloaded from CSR, Inc. website.
- If an error occurs, the frequency display flashes. In this case, turn off the power of this equipment and then turn it on again.
- For connecting with a mobile device or a tablet PC, an OTG cable is required. There may be a case where an Android cell phone cannot be connected with this equipment.

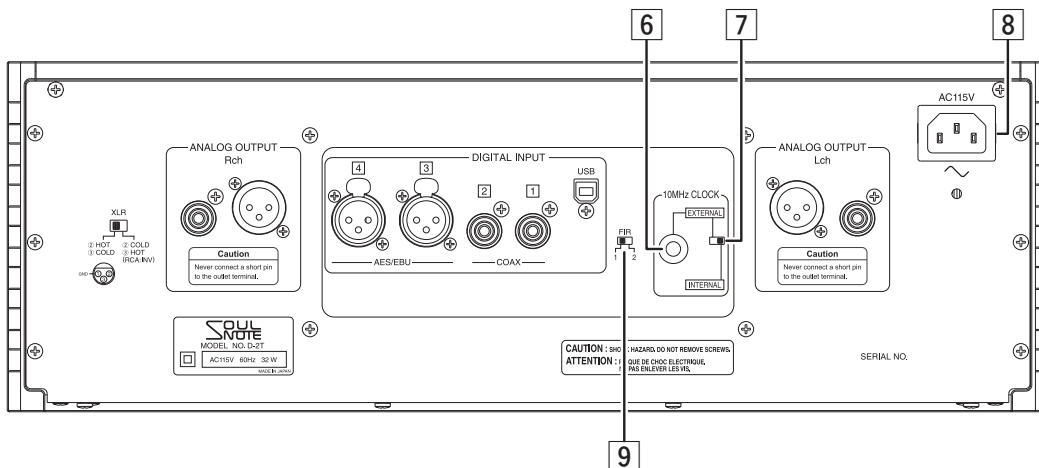

6 External Clock Input Terminal (10MHz CLOCK)

A device such as SOULNOTE X-3T that outputs 10 MHz reference clock can be connected to this terminal by using a 50-ohm SMA coaxial cable.

Notes:

- When connecting a device, make sure that the power of this equipment is off.
- When using a BNC coaxial cable, use the supplied BNC-SMA conversion plug.

7 External Clock Selector Switch

The clock setting can be switched between the internal clock and external clock.

Note:

- When switching the clock setting, make sure that the power of this equipment is off.

8 AC Inlet (AC115V)

Connect to a 115 V AC wall outlet (mains) with the supplied power cable.

Notes:

- To maintain the audio quality, use the supplied power cable.
- Connect the power cable to the AC wall outlet (mains) by inserting the power plug prong with the engraved OO symbols into the ground side (the longer hole). If you reverse the orientation of the power plug, you cannot fully enjoy the performance of the unit.
- Firmly insert the power cable into the end of the AC inlet.
- The ground terminal and the housing are not connected.

⚠ Cautions

- **Do not use any electrical contact cleaner or the like in the AC inlet area.**

9 FIR Filter Characteristic Selector Switch (FIR)

When in FIR mode, the FIR filter characteristic can be selected from the following options.

FIR1: Fast Roll-Off Linear Phase Filter

FIR2: Fast Roll-Off Minimum Phase Filter

Cautions

- When connecting a cable to any of the input terminals or output terminals, make sure that the power of this equipment is off.
- When performing any rear panel switch operations, make sure that the power of this equipment is off.
- If no external clock signal is input when the External Clock Selector Switch is set to EXTERNAL, all indicators will be flash. In such a case, check the 7 External Clock Selector Switch. If the SOULNOTE X-3T is connected, make sure the power cable is inserted all the way in.

USB Connection with a Computer

Windows

To play back DSD/PCM files, install the designated driver to your computer.

Recommended computer specifications

OS : Windows 7 or higher
CPU : Intel Core 2 processor,
1.6 GHz or higher
Memory : 1.0 GB or higher

Mac OS

Operations can be performed with a Mac OS X standard driver.

When using Bulk Pet, install a driver to your computer.

Recommended computer specifications

OS : Mac OS X 10.9 or later

When using for the first time (how to install the driver)

1. Access the following website to download the designated driver.
http://www.kcsr.co.jp/sn_software.html
2. Without this equipment connected to your computer, start your computer.
3. Before connecting this equipment to the computer, install the designated driver to your computer following the instructions.
4. After the installation completes, restart the computer.
5. After the restart operation completes, connect this equipment to the computer and then turn on the power of this equipment.
6. Operate the input selector of this equipment to select USB.
7. This equipment will be recognized by the computer and driver installation will start automatically.

Notes:

- Depending on the computer specifications, installation may take some time. Do not turn off both this equipment and the computer until an installation completion message appears.
- Depending on the operating system, certain settings may be required for sound to be output. Configure the settings according to the operating system usage instructions.

Balanced Input/Output

The XLR Connector is used for Balanced Input/Output. There are two types of connection, “European Type” and “USA Type”.

1. European Type (adapter for this equipment)

(pin 2 = HOT, pin 3 = COLD)



2. USA Type

(pin 2 = COLD, pin 3 = HOT)



On this equipment, use the XLR type selection switch (XLR) to select the desired type.

Attaching the Spike Pins

By replacing the feet with the supplied spike pins, you can tune the audio quality. Point grounding makes the sound focus and auditory lateralization sharper. Furthermore, the audio quality can be subtly tuned by changing the material of the surface on which this unit is installed.

Notes:

- When the spike pins are attached, it may be difficult to keep weight balance stable. Take great care not to carelessly apply a force on the corners of the main unit.

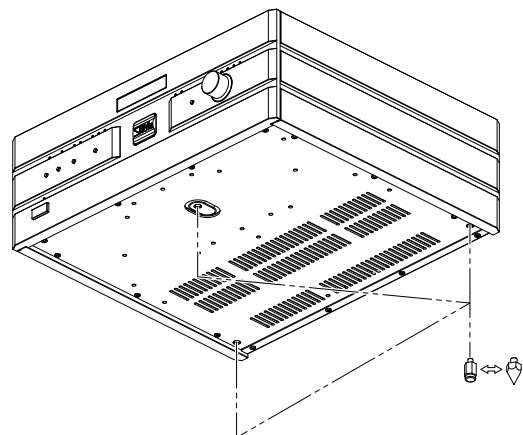

Cautions

- When using the spike pins, be extremely careful not to get injured, etc.
- Be careful so that the surface on which the unit is installed such as the surface of a table or a shelf does not become damaged.

Troubleshooting

No sound is output.

- Check that the power of this equipment is on.
- Check the external clock selector switch is not set to EXTERNAL.
- Check that the appropriate input source is selected with the input selector.
- Check the connections of the external devices.
- Check that the power of the external devices is on.
- Check that the operations and settings on the external devices are correct.
- Check that you are not attempting to input a signal that is not supported by this equipment.
- When using SOULNOTE X-3T as an external clock, check that the power cable of X-3T is inserted all the way in.

This equipment cannot be recognized by a device such as a music server.

- Check the connection with the device.
- Check that a USB hub is not being used.
- Check that the appropriate input source is selected with the input selector.

No sound is output from a device such as a music server.

- Check that the device settings are properly configured.

Maintenance

When the equipment has become dirty, wipe it clean using a soft cloth. To remove stubborn stains, dilute some dish-washing liquid in 5 or 6 times as much water, soak a soft cloth in the solution, wring it out well, wipe away the stains, and then wipe the surfaces dry with a dry cloth.

Never use alcohol, paint thinners, benzene, insecticides or other volatile substances since they may mar or remove the surface gloss.

Bear in mind that rubbing surfaces with a chemical cleaning cloth or leaving such a cloth in contact with a surface for an extended time may result in deterioration.

Specifications

Input format

USB PCM, DSD (DoP v1.1, ASIO)

Coaxial, AES/EBU PCM, DSD (DoP v1.1)

Supported sampling frequency

USB Max. 768 kHz for PCM,

Max. 22.6 MHz for DSD

Coaxial, AES/EBU Max. 192 kHz for PCM,

Max. 2.8 MHz for DSD64 DoP v1.1

PCM quantization bit rate

USB 16 bit, 24 bit, 32 bit

Coaxial, AES/EBU 16 bit, 24 bit

USB profile USB 2.0, USB Audio 2.0

Digital input..... USB (Type B),

2 coaxial inputs (S/PDIF), 2 AES/EBU inputs

External clock input 10 MHz (BNC 50 ohm)

Analog output 1 XLR output, 1 RCA output

Output level XLR : 6.2Vrms, RCA : 3.1Vrms

Frequency characteristic

..... 2 Hz to 120 kHz (+0/-1 dB)

S/N ratio..... 110 dB

Total harmonic distortion..... 0.04%

Analog filter..... first-order passive type

Power voltage..... 115 V AC, 60 Hz

Power consumption..... 32 W

Maximum external dimensions

Main unit..... 430 (W) x 160 (H) x 405 (D) mm

Weight 17 kg



SOULNOTE, Inc.

<https://www.soulnote.link/>