

A-1 ver.2 T User Guide

INTEGRATED AMPLIFIER

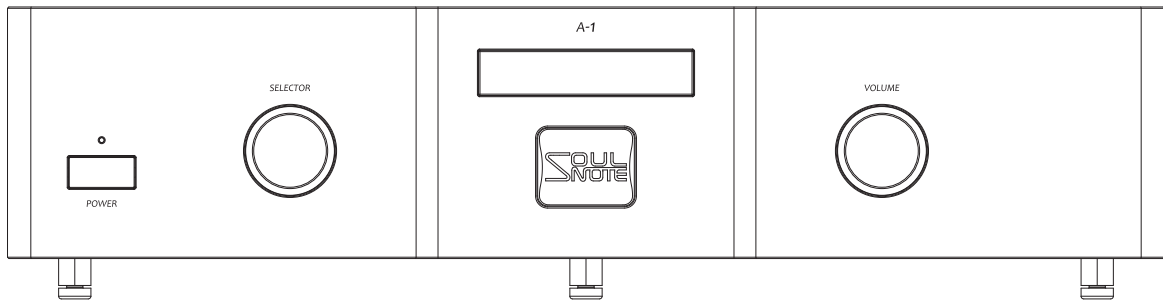

Table of Contents

| | |
|---|----|
| Safety Precautions..... | 3 |
| Front Panel Names and Functions | 6 |
| Rear Panel Names and Functions..... | 7 |
| Remote Control Button Names and Functions | 8 |
| Display | 9 |
| Remote Control..... | 10 |
| Balanced Input/Output | 11 |
| Attaching the Spike Pins..... | 11 |
| Aging..... | 12 |
| Troubleshooting | 12 |
| Maintenance | 12 |
| Specifications..... | 13 |

Supplied Accessories

| | | | |
|----------------------------------|---|----------------------------|---|
| • User Guide (this manual) | 1 | • Spike pin | 3 |
| • Power cable | 1 | • Hex key spike pins | 1 |
| | | • Remote control..... | 1 |

Safety Precautions



CAUTION

RISK OF ELECTRIC SHOCK
DO NOT OPEN



CAUTION: TO REDUCE THE RISK OF ELECTRIC SHOCK, DO NOT REMOVE COVER (OR BACK). NO USER-SERVICEABLE PARTS INSIDE. REFER SERVICING TO QUALIFIED SERVICE PERSONNEL.



The lightning flash with arrowhead symbol, within an equilateral triangle, is intended to alert the user to the presence of uninsulated “dangerous voltage” within the product’s enclosure that may be of sufficient magnitude to constitute a risk of electric shock to persons.



The exclamation point within an equilateral triangle is intended to alert the user to the presence of important operating and maintenance (servicing) instructions in the literature accompanying the product.

WARNING

TO REDUCE THE RISK OF FIRE OR ELECTRIC SHOCK, DO NOT EXPOSE THIS APPLIANCE TO RAIN OR MOISTURE.

A warning that an apparatus with CLASS I construction shall be connected to a MAINS socket outlet with a protective earthing connection.

IMPORTANT SAFETY INSTRUCTIONS

READ BEFORE OPERATING EQUIPMENT

This product was designed and manufactured to meet strict quality and safety standards. There are, however, some installation and operation precautions which you should be particularly aware of.

1. Read these instructions.
2. Keep these instructions.
3. Heed all warnings.
4. Follow all instructions.
5. Do not use this apparatus near water.
6. Clean only with dry cloth.
7. Do not block any ventilation openings.
Install in accordance with the manufacturer's instructions.
8. Do not install near any heat sources such as radiators, heat registers, stoves, or other apparatus (including amplifiers) that produce heat.
9. Protect the power cord from being walked on or pinched particularly at plugs, convenience receptacles, and the point where they exit from the apparatus.
10. Only use attachments/accessories specified by the manufacturer.
11. Use only with the cart, stand, tripod, bracket, or table specified by the manufacturer, or sold with the apparatus. When a cart is used, use caution when moving the cart/apparatus combination to avoid injury from tip-over.
12. Unplug this apparatus during lightning storms or when unused for long periods of time.
13. Refer all servicing to qualified service personnel. Servicing is required when the apparatus has been damaged in any way, such as power-supply cord or plug is damaged, liquid has been spilled or objects have fallen into the apparatus, the apparatus has been exposed to rain or moisture, does not operate normally, or has been dropped.
14. Batteries shall not be exposed to excessive heat such as sunshine, fire or the like.



CAUTION:

- To completely disconnect this product from the mains, disconnect the plug from the wall socket outlet. The mains plug is used to completely interrupt the power supply to the unit and must be within easy access by the user.
- Never use the unit with any other cord except the supplied power cord.

NOTE ON USE

WARNINGS

- Avoid high temperatures.
Allow for sufficient heat dispersion when installed in a rack.
- Handle the power cord carefully.
Hold the plug when unplugging the cord.
- Keep the unit free from moisture, water, and dust.
- Unplug the power cord when not using the unit for long periods of time.
- Do not obstruct the ventilation holes.
- Do not let foreign objects into the unit.
- Do not let insecticides, benzene, and thinner come in contact with the unit.
- Never disassemble or modify the unit in any way.
- Ventilation should not be impeded by covering the ventilation openings with items, such as newspapers, tablecloths or curtains.
- Naked flame sources such as lighted candles should not be placed on the unit.
- Observe and follow local regulations regarding battery disposal.
- Do not expose the unit to dripping or splashing fluids.
- Do not place objects filled with liquids, such as vases, on the unit.
- Do not handle the mains cord with wet hands.
- When the switch is in the OFF position, the equipment is not completely switched off from MAINS.
- The equipment shall be installed near the power supply so that the power supply is easily accessible.

DECLARATION OF CONFORMITY

We declare under our sole responsibility that this product, to which this declaration relates, is in conformity with the following standards:

EN60065, EN55032, EN55020.

Following the provisions of Low Voltage Directive 2014/35/EU and EMC Directive 2014/30/EU.

A NOTE ABOUT RECYCLING:

This product's packaging materials are recyclable and can be reused. Please dispose of any materials in accordance with the local recycling regulations. When discarding the unit, comply with local rules or regulations.

Batteries should never be thrown away or incinerated but disposed of in accordance with the local regulations concerning battery disposal. This product and the supplied accessories, excluding the batteries, constitute the applicable product according to the WEEE directive.



Pb

CAUTIONS ON INSTALLATION

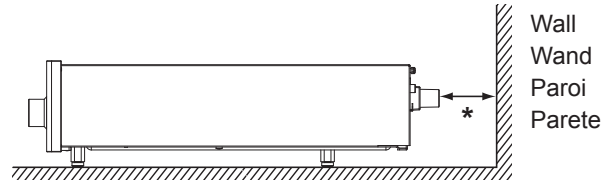
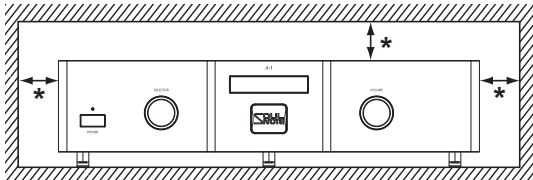

*** For proper heat dispersal, do not install this unit in a confined space, such as a bookcase or similar enclosure.**

- Leave sufficient clearance (at least 10 cm) from the wall, (at least 5 cm) from top surface of the unit.
- Do not place any other equipment on this unit.

Front Panel Names and Functions

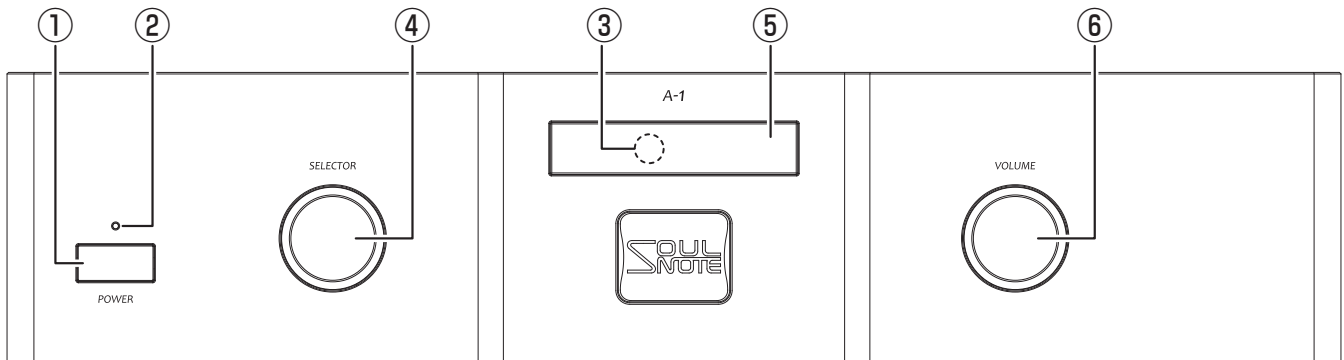

① Power Switch (POWER)

Press to turn on the power, and press again to turn off.

② Power Indicator (POWER)

When the power is turned on, the indicator is lit red.

③ Remote Sensor

The remote sensor receives infrared signals from the remote control.

④ Input Selector Jog Dial

An input source (1 to 4) can be selected by turning the jog dial.

When the display is off, press to display the current operation state.

Note:

- Even after turning off the power, the latest selection made with the jog dial will remain in the memory.

⑤ Display

Input source and volume are displayed.

⑥ Volume Jog Dial

Audio volume can be adjusted by turning the jog dial. Turn in clockwise to increase the volume. The volume can be adjusted in 36 increments from 0 to 35 increments.

Press to mute the audio output and press again to disable mute.

When mute is enabled, the display flashes.

Note:

- Even after turning off the power, the latest volume setting made with the jog dial will remain in the memory.

If the volume is set to 26 or higher, the volume of 25 will remain in the memory for your safety.

- An operation noise occurs during the volume setting due to relay switching inside the main unit. This is not a malfunction.

Rear Panel Names and Functions

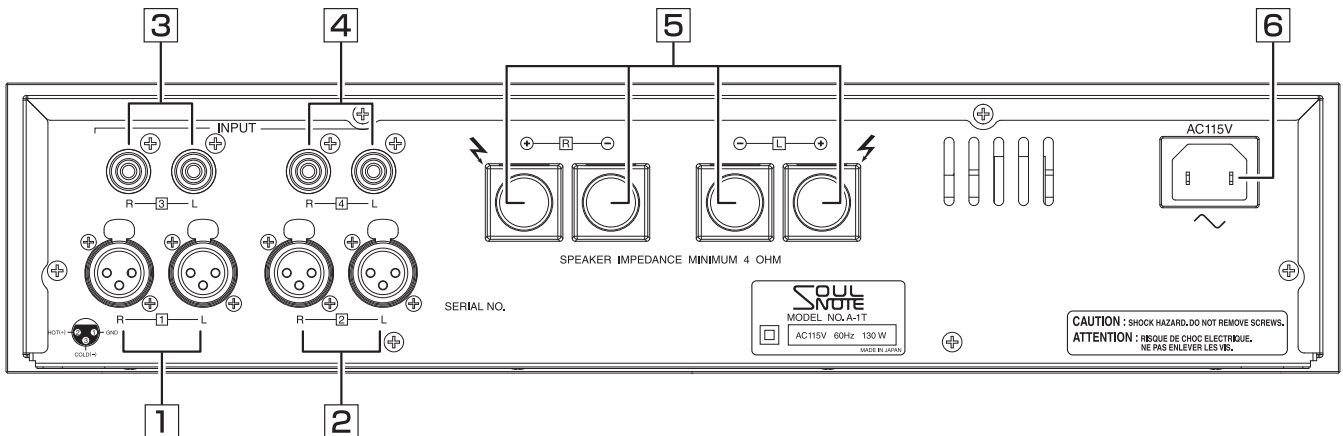

1,2 Input Terminals (XLR)

These terminals are used to input balanced audio signals via an XLR connector cable.

3,4 Input Terminals (RCA)

These terminals are used to input unbalanced audio signals via an RCA pin cable.

5 Speaker Terminals

These terminals are used for speaker connections. To each of these speaker terminals, 4-ohm or higher speakers can be connected.

Notes:

- Due to the superior frequency characteristic of the main unit, DO NOT connect any devices other than speakers. Connecting a speaker selector or measuring equipment causes a high-frequency connection of the input GND and the output GND, which may result in protection circuit activation or malfunction of the main unit.
- Place the speaker cables and the input cables as far away from each other as possible.
- Turn off the power before connecting a cable to the input terminal or the speaker terminal, or before reconnecting speakers that are connected via speaker cables.
- Connecting a speaker with less than 4-ohm impedance may cause sound distortion or protection circuit activation during playback.
- While each of output terminals consist of the ⊕ (red) and ⊖ (black) polarities, speaker systems also have the ⊕ and ⊖ polarities. Be sure to connect ⊕ to ⊕ and ⊖ to ⊖.

6 AC Inlet

Connect to a 115 V AC wall outlet (mains) with the supplied power cable.

Notes:

- To maintain the audio quality, use the supplied power cable.
- Connect the power cable to the AC wall outlet (mains) by inserting the power plug prong with the engraved OO symbols into the ground side (the longer hole). If you reverse the orientation of the power plug, you cannot fully enjoy the performance of the unit.
- Firmly insert the power cable into the end of the AC inlet.
- The ground terminal and the housing are not connected.

⚠ Cautions

- **Do not use any electrical contact cleaner or the like in the AC inlet area.**

Remote Control Button Names and Functions

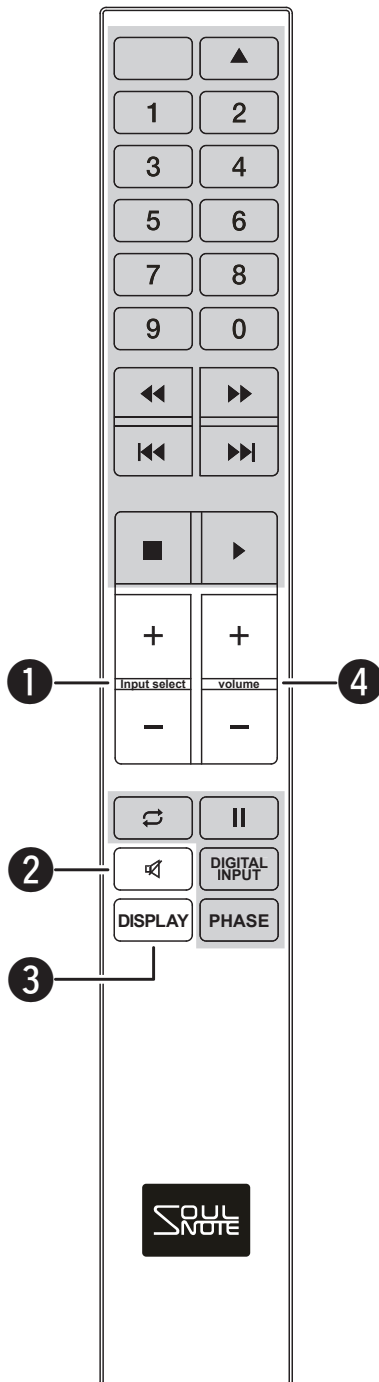

❶ Input select button

Press to select a desired input (1 - 6).
1 ↔ 2 ↔ 3 ↔ 4 ↔ 1 ↔ ...

❷ MUTE button

Press to mute the sound and press again to cancel mute.
While muted, the Volume Display flashes.

❸ DISPLAY button

Press to turn off the indicators and the display and press again to turn on.

Notes:

- While all the indicators and the displays are off, pressing any button causes the Volume Display to turn on. If any operation is not performed for about 2 seconds, the Volume Display automatically turns off.
- The Power Indicator does not turn off.
- Even while all the indicators and the displays are off, the Volume Display will flash when in the mute mode.

❹ Volume button

Press to adjust the volume. Press and hold the button to continuously increase/decrease the volume.

Notes:

- When increasing the volume, you cannot continuously increase the volume if the volume level is -20dB or higher.
- When decreasing the volume, you can continuously decrease the volume regardless of the volume level.

Note:

The grayed out portions are not available on this device.

Display

■ Normal Display

The single digit number on the left represents Input. The two-digit number on the right represents Volume.

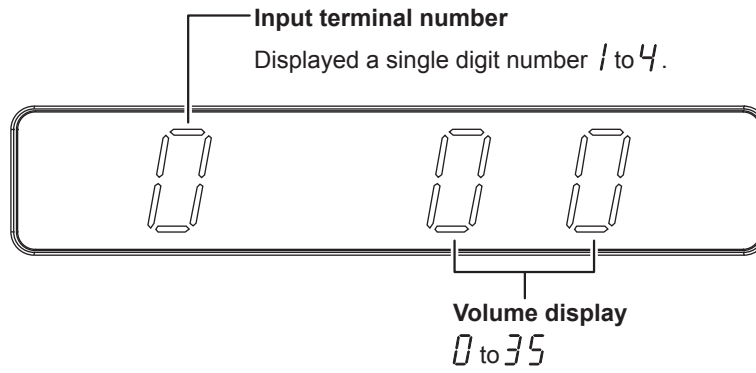

Remote Control

■ Notes on Operation

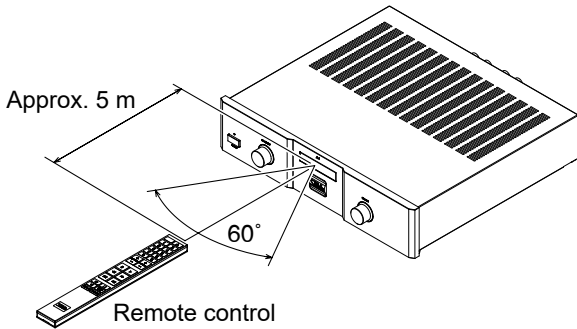

Operate the remote control within approx. 5 m distance from the front panel of the main unit within an angle of 60° to the remote sensor.

- Prevent the remote sensor from being exposed to strong light.
- Do not place any obstacles between the remote control and the remote sensor.
- Do not use other remote controls while using the remote control for the main unit.
- When using the remote control, keep the tip of the remote control facing the IR Sensor.

Cautions on Batteries

- Use CR2032 lithium batteries for the remote control.
- If you cannot operate the main unit by using the remote control at a short distance from the main unit, change the batteries with new ones.
- Do not use old and new batteries at the same time.
- Do not short-circuit, disassemble, or heat batteries. Do not throw batteries into a fire.
- Never leave batteries within reach of small children. If a battery is swallowed, immediately contact a doctor to seek medical attention.
- If your eyes come into contact with battery liquid, your eyes might get damaged. Avoid rubbing your eyes with and immediately flush your eyes with plenty of clean water such as tap water. After doing so, seek immediate medical attention.
- When not using the remote control for a long period of time, remove the batteries.

■ How to Change the Batteries

1. Remove the screw from the cover on the rear side of the remote control.

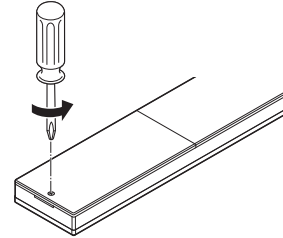

2. Lift up the cover diagonally to remove it.

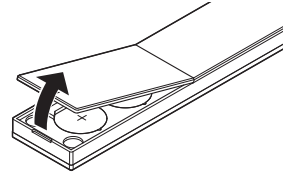

3. Use a thin yet sturdy oblong object to remove the batteries. Do not use any metal objects.

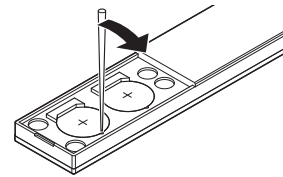

4. Insert the batteries with the + side facing upwards from the side indicated by the arrow.

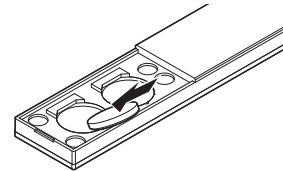

5. Insert the claw on the rear cover into the slit and then close the lid.

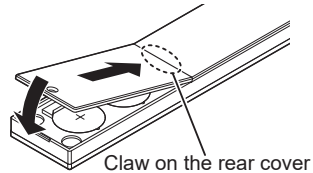

6. Use a driver to tighten the screw on the rear cover.

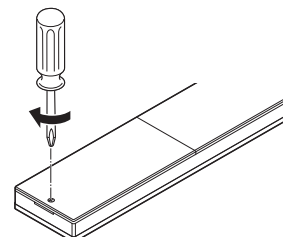

Balanced Input/Output

The XLR Connector is used for Balanced Input/Output. There are two types of connection, “European Type” and “USA Type”.

This unit adopts European Type of XLR connector. If the connecting equipment has the “USA Type” of XLR then audio signal becomes antiphase. In this case, swap pin 2 and pin 3 of XLR connector (INPUT or OUTPUT) to work same as European Type.

1. European Type (adapter for this unit)

(pin 2 = HOT, pin 3 = COLD)

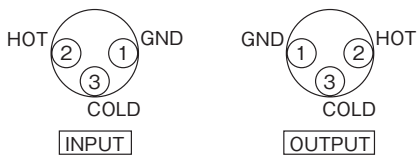

2. USA Type

(pin 2 = COLD, pin 3 = HOT)

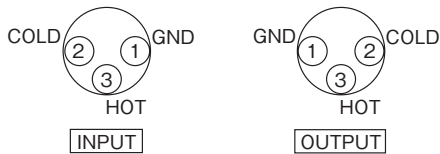

Attaching the Spike Pins

By replacing the feet with the supplied spike pins, you can tune the audio quality. Point grounding makes the sound focus and auditory lateralization sharper. Furthermore, the audio quality can be subtly tuned by changing the material of the surface on which this unit is installed.

Notes:

- When the spike pins are attached, it may be difficult to keep weight balance stable. Take great care not to carelessly apply a force on the corners of the main unit.

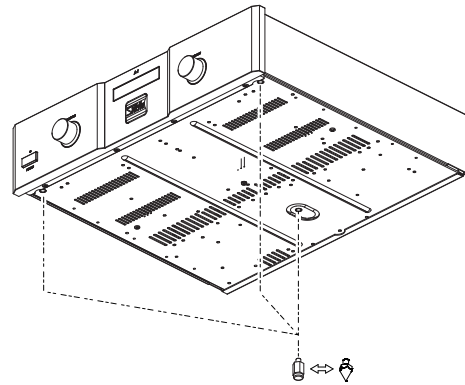

Cautions

- When using the spike pins, be extremely careful not to get injured, etc.
- Be careful so that the surface on which the unit is installed such as the surface of a table or a shelf does not become damaged.

Aging

The Audio products including Speaker system need the aging in general. Especially many sensitive parts to get high quality sound are used in this unit, the aging is very important factor.

This unit is shipped with enough aging process to get best sound performance.

Troubleshooting

No sound is output.

- Check that the power of the main unit is on.
- Check that the appropriate input source is selected.
- Check the connections of the external devices.
- Check that the power of the external devices is on.
- Check that the operations and settings on the external devices are correct.
- Check the connections of the speaker system.

The remote control does not operate.

- Check that the remote control batteries are not worn out.
- Check that the distance between the remote control and the main unit is not too far or that there is no obstacle between the remote control and the main unit.

Maintenance

When the unit has become dirty, wipe it clean using a soft cloth. To remove stubborn stains, dilute some neutral dish-washing liquid in 5 or 6 times as much water, soak a soft cloth in the solution, wring it out well, wipe away the stains, and then wipe the surfaces dry with a dry cloth.

Never use alcohol, paint thinners, benzine, insecticides or other volatile substances since they may mar or remove the surface gloss.

Bear in mind that rubbing surfaces with a chemical cleaning cloth or leaving such a cloth in contact with a surface for an extended time may result in deterioration.

Specifications

| | |
|---------------------------------|---------------------------------|
| Maximum output | 40 W x 2 (8 ohm) |
| | 80 W x 2 (4 ohm) |
| Total harmonic distortion | 0.3% (1 W, 8 ohm) |
| Frequency characteristic | |
| Speaker (8 ohm, 1 W) | 2 Hz to 200 kHz (± 1.0 dB) |
| Input sensitivity/impedance | |
| LINE1, 2 | 700 mV/16 kohm |
| LINE3, 4 | 700 mV/8 kohm |
| S/N ratio | 110 dB (IHF A network) |
| Power voltage | 115 V AC , 60 Hz |
| Power consumption | 130 W (EN60065) |
| | 40 W (during idling) |
| Maximum external dimensions | |
| | 430 (W) x 109 (H) x 418 (D) mm |
| Weight | 10 kg |



SOULNOTE, Inc.

<https://www.soulnote.link/>